

VTAP⁵⁰

Integration Guide - VTAP50 Reader Board

VTAP50-OEM

Revised January 2025 v1.54

If you need help to set up or use your VTAP50, beyond what is contained in this Integration Guide, then please contact our support team.

Email: vtap-support@dotorigin.com

Download the latest documentation and firmware from <https://vtapnfc.com>

Telephone UK and Europe: +44 (0) 1428 685861

Telephone North America and Latin America: +1 (562) 262-9642

If you have any feedback on setting up or using your VTAP50 or this documentation, then please contact our support team. The product is constantly being reviewed and improved and we value feedback about your experience.

Copyright 2025 Dot Origin Ltd. All rights reserved.

No part of this Integration Guide may be published or reproduced without the written permission of Dot Origin Ltd except for personal use. This Integration Guide relates to correct use of the VTAP50 only. No liability can be accepted under any circumstances relating to the operation of the user's own PC, network or infrastructure.

Dot Origin Ltd

Unit 7, Coopers Place Business Park, Combe Lane, Wormley

Godalming GU8 5SZ United Kingdom

+44 (0) 1428 685861

Contents

1 Using this guide	1
2 How the VTAP50 works	2
2.1 Default operation	3
2.2 Start reading your own passes	3
2.3 Check status in BOOT.TXT	7
3 Mechanical installation	9
3.1 Power	9
3.2 Environment	9
3.3 Mounting points	10
3.4 Optional captive cable connection - RS-232 and USB	11
3.5 Optional FFC Connector - USB and TTL serial	13
4 Optional external LEDs	14
4.1 Permanently disable on-board LEDs	16
5 Optional external antenna	17
6 Module integration instructions - FCC/ISED	19
6.1 Applicable FCC/ISED rules	19
6.2 Specific operational use conditions	19
6.3 RF exposure considerations	19
6.4 Antennas	19
6.5 Label and compliance information	20
6.6 Information on test modes	20
6.7 Additional testing requirements	20
6.8 Maintaining Apple ECP2/Access compliance	21
7 Hardware lock to disable USB mass storage device	22
8 Find your hardware version	23
9 Disposal	24
A Tested external antennas	A-1

Safety instructions



WARNING: INTENDED USE

The VTAP50 equipment is intended for use by suitably qualified integrators, who will integrate the VTAP50-OEM (PCB) into their own hardware, without any changes or modifications to the VTAP50-OEM device. (An optional enclosure can be supplied.) Components mounted on the VTAP50 PCB are not user-serviceable. Product safety has been tested to comply with IEC 62368-1.



WARNING: ESD PRECAUTIONS

We recommend careful handling and storage of Electrostatic Sensitive Devices (ESDs) during installation. The VTAP50-OEM PCB should always be protected by static shielding bags for shipping or storage.



WARNING: POWER SUPPLY

Use either a MicroUSB to USB cable, **or** the optional captive cable, if any, to connect the VTAP50-OEM PCB to a PC. (**Never** connect both at the same time).

EMC emissions and immunity certifications are only valid when using the VTAP50-OEM with the supplied cable.

**WARNING: FCC COMPLIANCE**

This device complies with part 15 of the FCC Rules. Operation is subject to the following two conditions:

- (1) This device may not cause harmful interference, and
- (2) this device must accept any interference received, including interference that may cause undesired operation.

NOTE: This equipment has been tested and found to comply with the limits for a Class B digital device, pursuant to part 15 of the FCC Rules. These limits are designed to provide reasonable protection against harmful interference in a residential installation.

This equipment generates, uses and can radiate radio frequency energy and, if not installed and used in accordance with the instructions, may cause harmful interference to radio communications. However, there is no guarantee that interference will not occur in a particular installation.

If this equipment does cause harmful interference to radio or television reception, which can be determined by turning the equipment off and on, the user is encouraged to try to correct the interference by one or more of the following measures:

- Reorient or relocate the receiving antenna.
- Increase the separation between the equipment and receiver.
- Connect the equipment into an outlet on a circuit different from that to which the receiver is connected.
- Consult the dealer or an experienced radio/TV technician for help.

Changes or modifications not expressly approved by the party responsible for compliance could void the user's authority to operate the equipment.

This equipment complies with FCC radiation exposure limits set forth for an uncontrolled environment. This equipment should be installed and operated with a minimum distance of 20 cm between the radiator and a human body.

If the identification number is not visible when the module is installed inside another device, then the outside of the device into which the module is installed must also display a label referring to the enclosed module, Contains FCC ID: 2A282-VTAP50.

Co-location of this module with other transmitters that operate simultaneously are required to be evaluated using the multi-transmitter procedures.

The host integrator must follow the integration instructions provided in this document and ensure that the composite-system end product complies with the requirements by a technical assessment or evaluation to the rules and to KDB Publication 996369.

The host integrator installing this module into their product must ensure that the final composite product complies with the requirements by a technical assessment or evaluation to the rules, including the transmitter operation and should refer to guidance in KDB 996369.

**WARNING: ISED COMPLIANCE**

This device contains licence-exempt transmitter(s) that comply with Innovation, Science and Economic Development Canada's licence-exempt RSS(s). Operation is subject to the following two conditions:

- (1) This device may not cause interference, and
- (2) this device must accept any interference, including any interference that may cause undesired operation of the device.

This equipment complies with ISED radiation exposure limits set forth for an uncontrolled environment. This equipment should be installed and operated with a minimum distance of 20 cm between the radiator and a human body.

L'émetteur exempt de licence contenu dans le présent appareil est conforme aux CNR d'Innovation, Sciences et Développement économique Canada applicables aux appareils radio exempts de licence. L'exploitation est autorisée aux deux conditions suivantes :

- (1) L'appareil ne doit pas produire de brouillage;
- (2) L'appareil doit accepter tout brouillage radioélectrique subi, même si le brouillage est susceptible d'en compromettre le fonctionnement.

Cet équipement est conforme aux limites d'exposition aux rayonnements de la ISED établies pour un environnement non contrôlé. Cet équipement doit être installé et utilisé avec une distance minimale de 20 cm entre le radiateur et un corps humain.

If the identification number is not visible when the module is installed inside another device, then the outside of the device into which the module is installed must also display a label referring to the enclosed module, Contains IC: 30458-VTAP50.

Si le numéro d'identification n'est pas visible lorsque le module est installé à l'intérieur d'un autre appareil, alors l'extérieur de l'appareil dans lequel le module est installé doit également afficher une étiquette faisant référence au module fourni, Contient IC : 30458-VTAP50.

1 Using this guide

This guide is for first-time users of the VTAP50-OEM reader board.

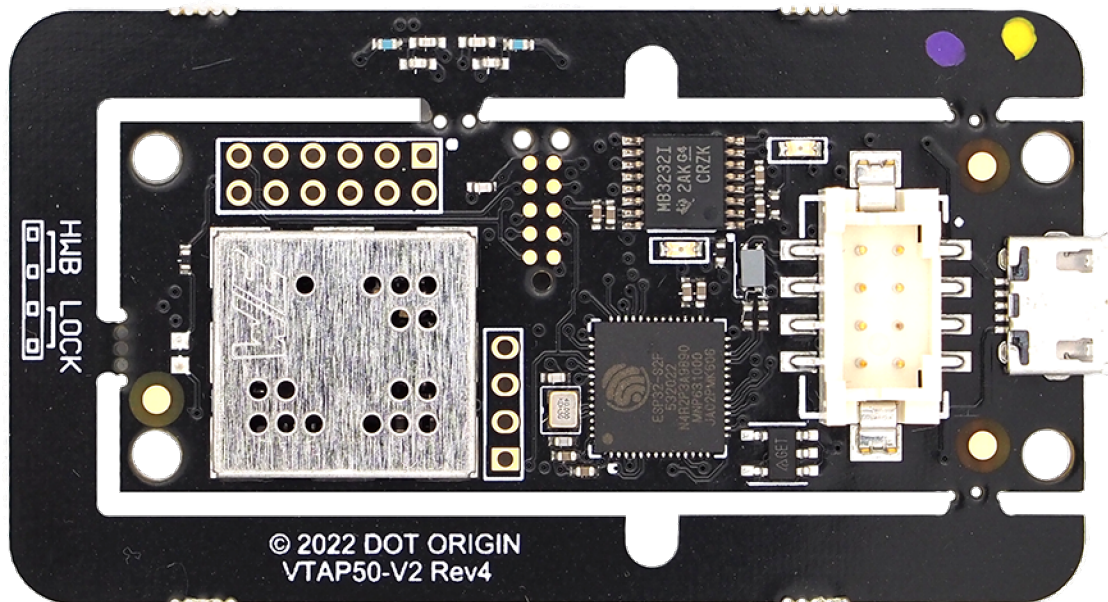

Figure 1-1 VTAP50 reader board

It contains the information you need about your VTAP50 hardware.

Consult the VTAP Configuration Guide for more about configuration and maintenance features, including how to update the firmware on your VTAP50 unit, when a new release is available. The firmware on a VTAP50 functions in exactly the same way as that used on a VTAP100, so you can refer to generic VTAP Configuration Guides.

If you need help beyond what is contained in this guide please contact vtap-support@dotorigin.com.

2 How the VTAP50 works

With the VTAP50-OEM connected to a PC, simply tap your smartphone against the VTAP50. Your mobile NFC pass will be read and data sent to the connected PC.

Of course, the data can only be read if your phone contains a mobile NFC pass, which has been issued in connection with the Merchant ID(s)/Collector ID(s) and ECC key(s) that are known to the VTAP50. The unit comes with default values, so that you can test **Default operation on factory settings** before you begin customising any settings.

When the VTAP50-OEM reader board is connected to a computer it appears as a generic mass storage device (like a memory stick). To configure your VTAP50, you simply edit or create text files. These will be read automatically, and control the operation of the VTAP50. Consult the VTAP Configuration Guide for more detail. The firmware on a VTAP50 functions in exactly the same way as that used on a VTAP100, so you can refer to generic VTAP Configuration Guides.

By default the VTAP50 is fully upgradable in the field. However, the VTAP50 can be locked in software or hardware, before deploying the unit, so that operation is no longer easily changed.

2.1 Default operation

Before anyone changes the configuration from its default, you can confirm that the unit is working.

These steps demonstrate that the hardware can detect and interact with an OriginPass demo mobile NFC pass, which is ready to work with the default configuration of your VTAP50.

1. Obtain an OriginPass from Dot Origin by visiting <https://originpass.com/VTAP/> and add it to Google or Apple Wallet. (You will require a username and password – contact vtap-support@dotorigin.com to get these.)
2. Connect the VTAP50 to your PC, using a USB cable.
3. Open a text editor, such as Windows Notepad.
4. When you tap the OriginPass on the VTAP50:
 - Pass contents will be displayed in the open text editor, through keyboard/barcode emulation.
 - The feedback LEDs on the VTAP50 PCB will flash green.
 - Your smartphone may signal with a buzz or beep.

Note: Some Android phones will only interact if their screen is on, although it does not need to be unlocked. You may need to enable NFC in the settings for the smartphone.

Note: If the pass detected does not match the key and ID on the VTAP, or is moved away too quickly to be read, the pass contents displayed may be an 8 digit random hex string, such as '08E22AC1', different on each presentation. OriginPass contents will be a consistent string, such as '3~ffymeK9f_mziYtA6~53999301628695~Valued'. Any separator, such as '~' or '|', will depend on your keyboard language settings. (See VTAP Commands Reference Guide for option to ignore random UIDs if needed.)

Note: If local security settings prevent or limit the use of removable storage devices, or the connection of additional keyboards, an administrator may need to alter those permissions.

2.2 Start reading your own passes

If you navigate to the VTAP in the computer's file system, it will appear as an attached mass storage device and list the files contained, including the main `config.txt` file.

To read any mobile NFC pass, you will need to provide your pass reading parameters in the `config.txt` file. This means a collector ID or merchant ID and ECC keys. These allow you to read and decrypt pass data that is held by your users, on their smartphones. (There is a VTAP Application Note which explains more about ECC key pairs and how to generate your own keys.)

This first time, you will need to connect the VTAP50 to your PC, using a USB cable. (If needed, you can make changes remotely in future over a virtual COM port or serial port, see VTAP Serial Integration Guide.)

Step 1: Upload private key file(s) to your VTAP50

1. Ensure these are ECC private key(s). Each is stored in a file with the name `private#.pem`, following the `.pem` format, where # is replaced with a number from 1 to 6, matching the key slot you will save it in. (The demo passes are accessed using the key in KeySlot 6, so don't overwrite this one unless you are finished with Dot Origin demo passes.)

Note: A VTAP reader cannot use more than 6 private key files.

2. Load your keys by copying these files onto your VTAP50, which shows up in the file system of your PC as a mass storage device.

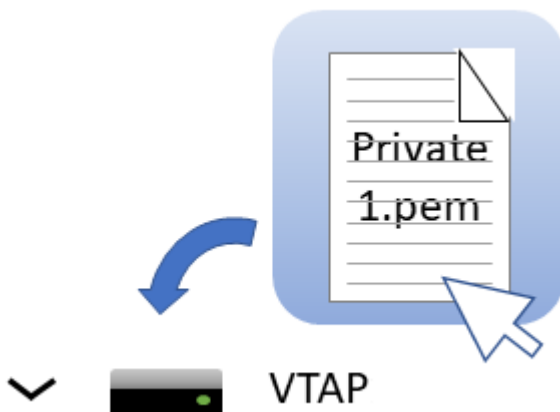

Note: When you reboot the VTAP50 your key will have been stored in hardware, and will no longer be listed as a file on the device. You can confirm key file(s) have been loaded when you **Check status in Boot.txt**. If the key file does not disappear and there is an error in `Boot.txt`, check your `.pem` file as it is likely it did not adhere to the standard - perhaps it was not an ECC key?

Step 2: Declare Merchant ID(s)/Collector ID(s) in the `config.txt` file

1. Open the file `config.txt` in a text editor (such as Windows Notepad). It already contains parameters for accessing the demo passes, prefixed `VAS1` and `ST1`, both relying on KeySlot 6. You can overwrite these, or keep them in addition to your own pass reading parameters.
2. Add your pass reading parameters in the `config.txt` file to access up to 6 Apple VAS and up to 6 Google Smart Tap IDs, and identify the keys to be used in each case.

Note: Although the VTAP50 supports multiple IDs, Apple expect most users will only use one. Multiple collector IDs are not supported by Android, which means you cannot request more than one Collector ID from Google. Only one should be live at any one time. Multiple IDs is an advanced feature that should be used with care. The `VAS#` and `ST#` numbers define the order in which IDs will be requested from Apple or Android phones respectively. The lowest numbered ID will be requested first, then continuing in ascending numeric order. (There is a VTAP Application Note on Multiple Passes which explains more.)

Put each parameter on a new line. Order of parameters does not matter to the VTAP50, but could help other people who need to edit the file. Start any comment lines in the `config.txt` file, that the VTAP50 should ignore, with a semicolon. Each parameter should only appear once - if it accidentally appears more than once then only the last instance will take effect.

Example: Settings in `config.txt` to interact with both Apple VAS and Google Smart Tap mobile passes

```
!VTAPconfig

VAS1MerchantID=<your merchant ID>
VAS1KeySlot=1
; This says use the key added as file 'private1.pem' to read and
; decrypt any pass connected to your merchant ID on an Apple iPhone

ST1CollectorID=<your collector ID>
ST1KeySlot=2
ST1KeyVersion=1
; This says use the key added as file 'private2.pem' at key version 1
; to read and decrypt any pass connected to your collector ID
; on an Android phone
```

3. Save the amended `config.txt` file and these changes will take effect immediately. (A small number of changes to the `config.txt` file require a reboot to take effect, for instance to the status of the virtual COM port, but these are highlighted in later sections).

Note: If a `VAS#KeySlot` parameter is omitted, or set to 0, then all available keys will be automatically tried to choose the right key. If the data received by the VTAP50 cannot be decrypted, the Apple iPhone will register a pass read, but the data will not be output.

Note: If an `ST#KeySlot` parameter is omitted, or set to 0, then authentication will be omitted and decryption will not be performed. In this case, Google Smart Tap data will be received and sent on by the VTAP50, only if the pass does not require authentication by the terminal.

2.3 Check status in `BOOT.TXT`

If you navigate to the VTAP50 in the computer's file system. It will appear as an attached mass storage device and list the files contained, including the `BOOT.TXT` file.

Inspecting `BOOT.TXT` will give you essential information about your VTAP50 set up, at time of last reboot, which might be helpful when troubleshooting.

```
VTAP50
Boot time: 1970/01/01 00:00:00
Firmware: V2.2.4.0
Storage: Dataflash
Status: 0
Hardware: 2.00
Expansion: None
VCP enabled
NCI: 0471125005-8C00
Serial number: 563230-29F1F2ADC2261743BDB1B8405FFD603E
API level: 4
AppKeys used: 123-----
KeySlots used: ----56
```

Figure 2-1 Example VTAP50 v2 `BOOT.TXT` file

You are most likely to need:

- 'Serial number' - the hardware serial number for your VTAP50.
- 'VTAP label' (if set) - the assigned serial number for your VTAP50, which matches that on its label. This will not show if not set.
- 'Firmware' - the VTAP50 core firmware version in use. You will find the latest firmware versions at <https://www.vtapnfc.com/download/>
- 'Hardware' - the VTAP50 hardware version in use.
- 'API level' - indicates which serial or OSDP API commands are supported.
- 'KeySlots used:' - Indicates the ECC private keys loaded on the VTAP to access VAS or Smart Tap passes. Helps you check whether you have uploaded the necessary ECC private keys, which can be unclear as the files are deleted when they are uploaded. These two examples show how to read this information:
 - 'KeySlots used:-----' shows that no keys have been uploaded.
 - 'KeySlots used: 12--56' shows that key files 1 and 2 have been successfully uploaded, in addition to the defaults 5 and 6.
- 'AppKeys used:' Indicates the application keys (if any) uploaded to the VTAP for any other applications, such as keys loaded to use with DESFire applications.
- 'VCP enabled', if included - indicates that the virtual COM port has been enabled.

- 'Status' - should be 0 if operating normally, anything else indicates an error state.
- 'Boot time' - The time at boot, which defaults to 1970/00/00 00:00:00 if power is removed to reboot.

If the configuration has been locked the `BOOT.TXT` file will end with the words LOCKED S/W or LOCKED H/W.

3 Mechanical installation

The VTAP50 reader board for integration comprises a PCB with an integral antenna around the perimeter of the board, and can be powered either by a micro-USB to USB cable or a captive USB cable.

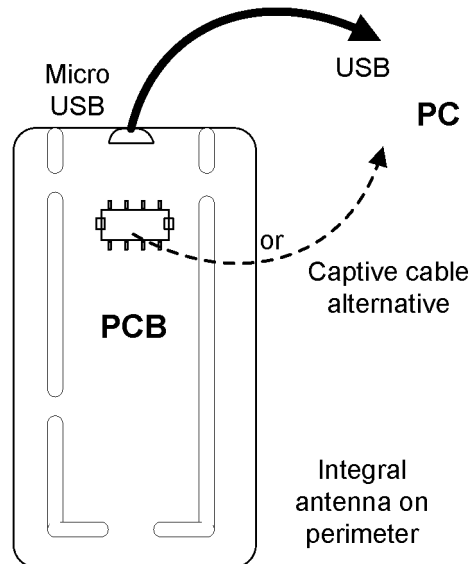

Figure 3-1 VTAP50 connections - v1 or v2 Hardware



WARNING: Observe all [Safety instructions](#) when installing the VTAP50 PCB.

3.1 Power

Connect the PCB to a PC using either a MicroUSB to USB cable or the optional captive cable (see section [3.4](#)).

The VTAP50 is rated at 5V DC (typ. 110mA, max 150mA) for power over USB.



WARNING: Do not power the VTAP50-OEM reader board if its antenna has been removed, or is damaged. Components can reach higher operating temperatures than normal when an antenna is not attached, which could damage the VTAP reader and cause injury if handled.

3.2 Environment

The VTAP50 must be stored and operated under the following conditions:

- Ambient temperature -25 to +70°C (-13 to 158°F)
- Humidity 0 to 95% RH non-condensing
- Pressure 86-106kPa

CAUTION: Always ensure sufficient clearance between the VTAP antenna and other RF transmitters, to avoid electromagnetic interference between equipment. Clearance required varies between antennas, depending on antenna size, power and sensitivity.

3.3 Mounting points

The PCB has 2.7mm diameter mounting holes for fixing the unit. Use 2-4 small nuts and bolts to mount the board securely.

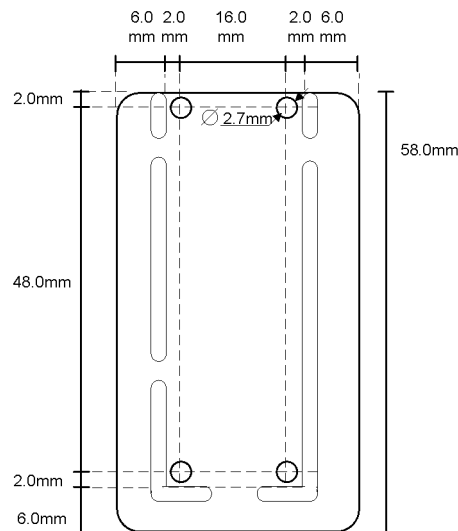

Figure 3-2 VTAP50 PCB mounting holes - v1 or v2 Hardware

The VTAP antenna should not be mounted more than 10mm deep within your enclosure (measuring from the antenna surface to the enclosure surface), so that a user's smartphone will be able to come close enough to the antenna for reliable reading.

The antenna position should be clearly marked and easily accessed, so that users can position their smartphone appropriately. Be aware that antennas are positioned differently in different makes of smartphone. Apple iPhones often have antennas near the top and Android phones are more likely to have an antenna in the middle.

CAUTION: Mounting a VTAP board near metal can reduce performance of the VTAP50, because metal can distort the NFC field. Never allow a metal surface between the VTAP50 and the user's phone or card. If you have to mount the VTAP50 near metal, you should ensure the separation is:

- at least 6mm and insert a ferrite sheet between the VTAP50 and any metal surface behind the reader, or
- at least 25mm separation between the VTAP PCB and any metal.

Testing should be performed in the proposed mounting location, as other devices and structures in close proximity could affect pass reading performance.

3.4 Optional captive cable connection - RS-232 and USB

The PCB has a special connector J1 (an 8 pin, 2mm pitch header connector) which can be used to attach a captive cable with a matching crimp housing, for RS-232 or an alternate USB connection.

The standard connector fitted to the PCB, in most cases, is a Hirose DF11CZ-8DP-2V male header plug with shroud. The matching crimp housing is the Hirose DF11-8DS-2C.

CAUTION: If the J1 connector on your PCB does not include a shroud, to guide the matching wires into place, you can use a wider range of mating connectors. Do please take extra care to ensure your connecting cable is oriented correctly to match the pins.

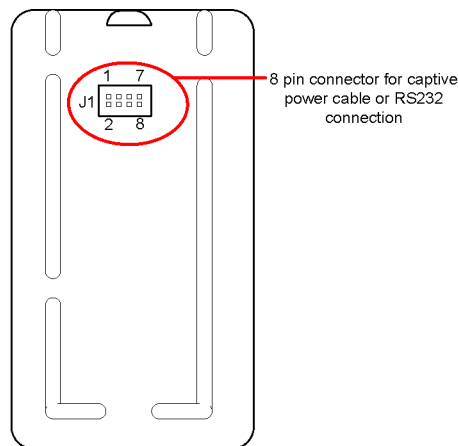

Figure 3-3 VTAP50 captive power cable or RS-232 connection - VTAP50 v1 Rev 2 or v2 Hardware onwards

CAUTION: There are a small number of VTAP50 v1 Rev 1 units in circulation. Please be aware that the pins on v1 Rev 1 hardware are pairwise switched.

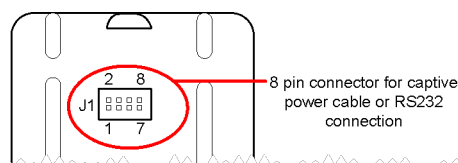

Figure 3-4 VTAP50 captive power cable or RS-232 connection - VTAP50 v1 Rev 1 Hardware only

The connector J1 includes both USB and RS-232 signals, as follows:

Pin	Function
1	GND
2	USB D+
3	+5V supply
4	USB D-
5	RS232 RXD (input)
6	Reserved (sense input)
7	RS232 TXD (output)
8	Reserved (sense GND)

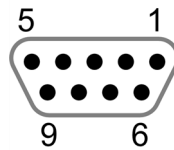

Figure 3-5 Typical RS-232 cable

A typical RS-232 cable has the following DB9 female connector pinout:

Pin	Function
2	TXD
3	RXD
5	GND
9	+5V supply

A PC or terminal RS-232 connector is usually DTE (data terminating equipment), typically a male DB9 with TXD on pin 3 and RXD on pin 2. The appropriate connecting cable is then a DCE (data communications equipment) female DB9. TXD and RXD pins are swapped between the DCE and DTE devices, so that the transmit pin on one connects to the receive pin on the other.

The VTAP50 requires a 5V power supply, but not all RS-232 devices have 5V on pin 9.

Either:

- Disconnect the USB cable before making the serial connection, if power will be provided by J1 (pins 1 and 3) and the serial cable/host.
- Or retain a USB connection in addition to the serial connection, if power is not available from your RS-232 device.

Some serial cables have a separate DC 5.5/2.1mm barrel connector to supply power. In these cables, typically, the centre pin is +5V and the outer barrel is GND.

3.5 Optional FFC Connector – USB and TTL serial

The FFC connector is found on the under side of the VTAP50 PCB.

Note: The Flexible Flat Cable (FFC) expansion connector is only suitable for USB and TTL use from VTAP50 v2 onwards.

Make a TTL 3.3V serial connection to pins 8 and 9 of the 12 way 0.5mm FFC connector:

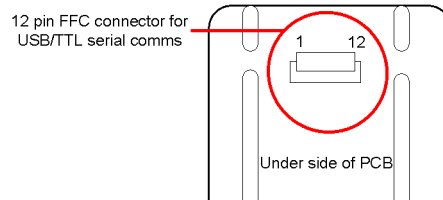

Figure 3-6 FFC connector (where fitted) – VTAP50 v2

Pin	Function
1	-
2	-
3	-
4	-
5	-
6	USB D+
7	USB D-
8	Tx (serial comms 3V3)
9	Rx (serial comms 3V3)
10	USB 0V
11	USB +5V
12	-

Enabling the RS-232 serial port in your VTAP configuration will enable these TTL pins as well as the usual RS-232 interface.

The RS-232 serial interface on the main 8-pin connector is generally preferred because these TTL signals are not buffered and are not 5V tolerant, so must be used with caution, to interface with other 3.3V circuits only.

You can control and configure the VTAP through this serial RS-232 TTL interface, either by itself or while retaining the USB keyboard emulation output mode, which can be useful when testing. You can change the way the data is presented (eg with prefixes and postfixes) to suit your target receiving device/application.

Note: TTL serial is also available from the expansion header used to connect external LEDs or antennas, from VTAP50 v2 onward.

4 Optional external LEDs

The VTAP50 v1 board does not have feedback LEDs, which are present on the VTAP50 v2 board.

An external RGB LED can be configured to show a default colour permanently, and then automatically change colour (or flash) in response to a successful pass read, successful card read or other error conditions. This is done by changing the `config.txt` file. The external RGB LED can also be driven over a command interface.

On VTAP50 v2 boards with firmware from v2.1.11.2, a chain of serial LEDs can be connected to the serial LED connection on the expansion header. A chain of serial LEDs supports more complex LED options and requires a special `leds.ini` file to control their behaviour. This special configuration is explained in the VTAP Configuration Guide.

Note: Where status LEDs are fitted alongside a chain or matrix of serial LEDs, they duplicate the behaviour of the first two LEDs in the chain. If this is problematic for your application, consider the option to **Permanently disable on-board LEDs**.

The expansion connector is not fitted as standard, but can be soldered in later.

Connect your external LED to the expansion header:

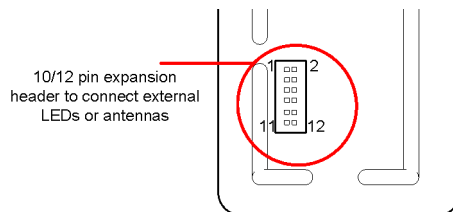

Figure 4-1 Expansion header (where fitted) - VTAP50

Pin	Function
1	Remote antenna
2	Remote antenna
3	GND
4	GND
5	+3V3 (out)
6	+5V (in/out)
7	LED (red) / LED serial 5V logic
8	LED (green)
9	LED serial 3V3 logic
10	LED (blue)
11 (v2 boards only)	Rx (serial comms 3V3)
12 (v2 boards only)	Tx (serial comms 3V3)

The external LED outputs are buffered 5V without any current limiting resistors, so you should attach a RGB LED board module that includes built-in current limiting resistors. (We recommend 15mA per LED output at 5V, so the maximum current required is 350mA. External LEDs should be decoupled, with 10 μ F bulk capacitance per LED along the LED path) The VTAP50 can support both common cathode and common anode, by changing the `LEDSelect` setting in the `config.txt` file.

4.1 Permanently disable on-board LEDs

If you are using optional external LEDs you may want to permanently disable the on-board LEDs.

The on-board LEDs are fed from the same serial LED lines (though buffered) as those provided on the expansion pads, as LEDs 0 and 1 in the chain. Since external LEDs will also use these addresses, it may be necessary to disable the on-board LEDs, if they are not also required for your application.

Where fitted, the two serial on-board LEDs are visible on the underside of the VTAP50 board:

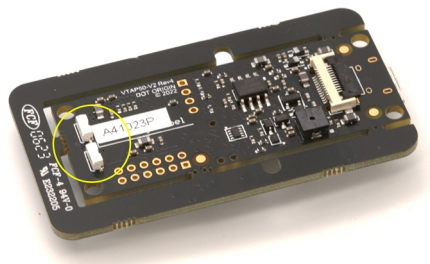

Turning to the top of the VTAP50 board, you can identify the associated pads:

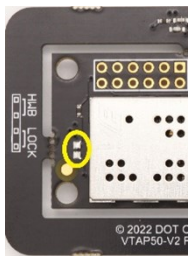

Using a sharp knife, cut the track between the pads, following the red line in the picture below:

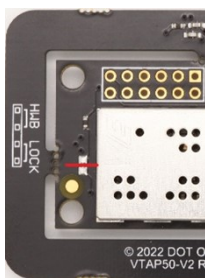

5 Optional external antenna

The VTAP50-OEM has an option to snap off the on-board antenna and connect an external antenna, with a suitable matching circuit, to the VTAP50-OEM.

Dot Origin can provide support for integrating external off-the-shelf or custom NFC antennas with VTAP50-OEM readers. More detail is provided in VTAP Application Notes.

Note: The VTAP50-OEM reader board has been EMC tested with its integrated loop antenna, printed on the PCB. The VTAP50-OEM reader board is designed so that you can carefully break the integrated antenna from the board and connect an external antenna, or buy the VTAP50-OEM without its antenna, sold as VTAP50-MOD.

A list of tested external antennas is provided in Annex **A**. If any external antenna is attached to the VTAP50 module, that new arrangement will require corresponding tuning circuits and EMC approvals. Contact vtap-support@dotorigin.com for details about tuning circuit and EMC approvals for the tested external antennas.

Attaching an external antenna uses the same expansion header as for external LEDs.

1. Snap off the VTAP50-OEM on-board antenna. We recommend that you break the snap off points by applying pressure with a screwdriver, when the PCB is lying on a flat surface.

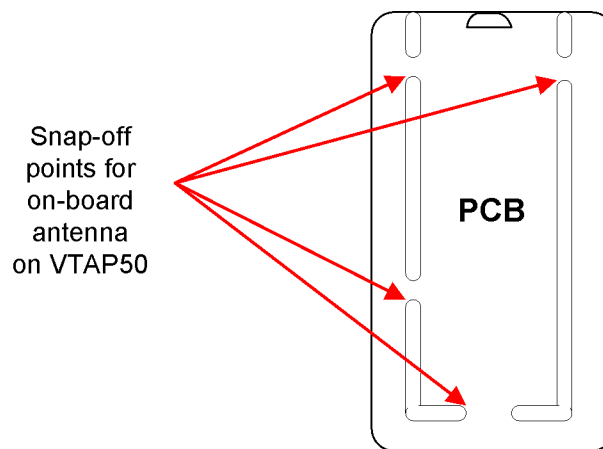

Figure 5-1 Points on VTAP50 to snap off the on-board antenna.

2. Then connect the external antenna to the VTAP50 using the 10/12 pin expansion header via a matching or tuning circuit (see examples in the VTAP Application Notes). The pins 1 and 2 on the expansion header are used for external antenna connection.

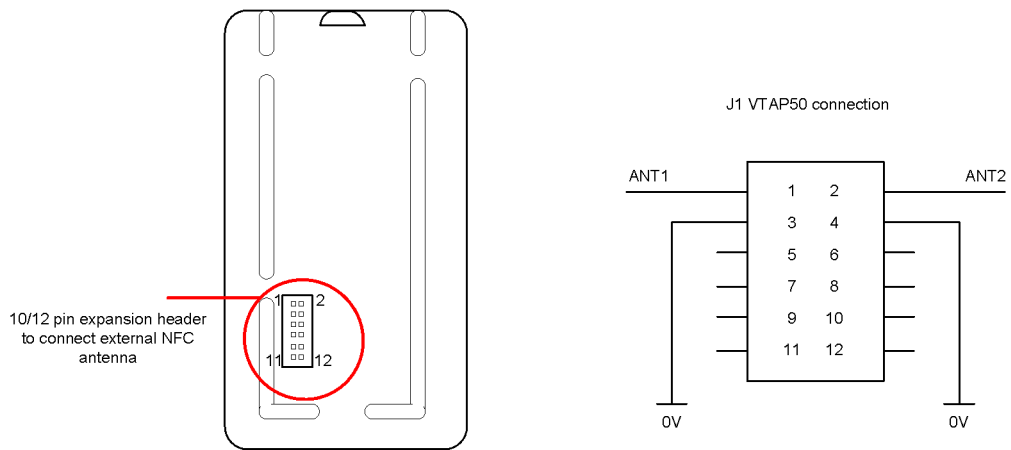

Figure 5-2 Expansion header to connect external antenna

CAUTION: Always ensure sufficient clearance between the VTAP antenna and other RF transmitters to avoid electromagnetic interference between equipment. The clearance required varies from antenna to antenna, depending on antenna size, power and sensitivity.

6 Module integration instructions – FCC/ISED

The VTAP50-OEM reader board has been designed to comply with the limits for a Class B digital device, pursuant to Part 15 of the FCC Rules. Operation is subject to the following two conditions:

- (1) This device may not cause harmful interference.
- (2) This device must accept any interference received, including interference that may cause undesired operation

These instructions must be followed to maintain the FCC/ISED approval for the VTAP50-OEM reader board, when it is integrated into a host system.

CAUTION: Changes or modifications made to the VTAP50-OEM reader board, that have not been expressly approved by Dot Origin Ltd could void the user's authority to operate the equipment.

6.1 Applicable FCC/ISED rules

The VTAP50-OEM reader board operates at 13.56MHz and is therefore subject to FCC/ISED rules for radio frequency devices.

6.2 Specific operational use conditions

The VTAP50-OEM reader board must be stored and operated under the following conditions:

- Ambient temperature -25 to +70°C (-13 to 158°F)
- Humidity 0 to 95% RH non-condensing
- Pressure 86-106kPa

6.3 RF exposure considerations

The VTAP50-OEM complies with FCC/ISED RF radiation exposure limits set for an uncontrolled environment. This equipment should be installed and operated with a minimum distance of 20 cm between the radiator and a human body.

Screened cable should be used, wherever possible, to connect VTAP50-OEM reader board to other devices, to avoid interference from other equipment.

The end-user manual for the host equipment, that contains a VTAP50-OEM reader board, must clearly indicate the operating conditions to be observed, so that the user remains in compliance with current FCC/ISED RF exposure guidelines.

6.4 Antennas

The VTAP50-OEM reader board has been tested with its integrated loop antenna, printed on the PCB. The VTAP50-OEM reader board is designed so that you can carefully break the

integrated antenna from the board and you can connect an external antenna. A list of tested external antennas is provided in Annex . If any external antenna is attached to the VTAP50, that new arrangement will require a corresponding tuning circuit and FCC/ISED approval. Contact vtap-support@dotorigin.com for details about tuning circuits and FCC/ISED approval for the tested external antennas.

6.5 Label and compliance information

The integrator must attach a label to the new equipment, hosting the VTAP50-OEM reader board, which states 'Contains FCC ID: 2A282-VTAP50' for FCC approval and 'Contains IC: 30458-VTAP50' for ISED approval.

6.6 Information on test modes

The following test modes are recommended to achieve states of maximum emission levels or susceptibility in the VTAP50-OEM reader board:

1. VTAP50-OEM reader board powered on. Communicating with PC over USB. Continuously reading tag.
2. VTAP50-OEM reader board powered on and tag present, but not communicating with external device.

6.7 Additional testing requirements

The VTAP50-OEM reader board is only FCC/ISED authorised for use in compliance with the specific FCC/ISED transmitter rules listed on the grant. The integrator is responsible for compliance to any other FCC/ISED rules that apply to the host, which are not covered by the modular transmitter grant of certification.

The final host product, with the VTAP50-OEM reader board installed, will still require Part 15 Subpart B compliance testing, to evaluate transmission effects when the VTAP50-OEM reader board and host equipment operate at the same time. Be aware that additional testing can be required on the final integrated system. We recommend integrators refer to further advice from the FCC OET Knowledge Base, such as [**996369 D04 Module Integration Guide v02**](#).

6.8 Maintaining Apple ECP2/Access compliance

In order to maintain Apple ECP2/Access compliance, it is essential that the new equipment hosting a VTAP reader board or module is tested. This must ensure that the new equipment will read mobile wallet NFC passes when a smartphone is held at least 4cm from the surface of the equipment (both with and without Express mode enabled on the Access pass in the wallet).

7 Hardware lock to disable USB mass storage device

You can lock the VTAP reader so that its firmware and configuration cannot be changed. You can either do this in software, or simply disable the mass storage device in hardware.

A software lock prevents changes but leaves the file system readable. A hardware lock means that the VTAP reader will no longer be detected as a USB mass storage device. (It will still behave as an HID keyboard device and, if enabled, the virtual COM port will behave as a composite USB device consisting of HID keyboard and USB virtual COM port.)

You can use a hardware lock provided that the jumper labelled LOCK (close to the MicroUSB connector) remains accessible.

Note: On VTAP50 reader boards or modules, although the contact is present, connector pins and jumpers will need to be supplied.

Connect a jumper across LOCK on the PCB to lock the device, preventing firmware or configuration changes via the mass storage device. (You may still update firmware or configuration via command interfaces, virtual COM port or serial ports, if they are enabled.)

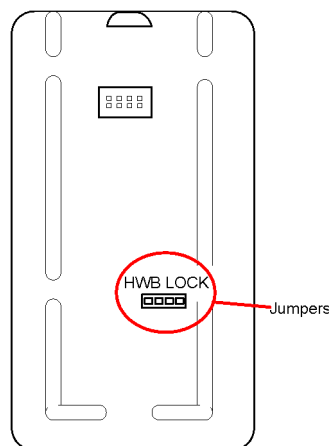

Figure 7-1 Jumper positions on VTAP50 PCB v1 or v2 hardware

When you start the VTAP50, the presence of this jumper means the connected PC will not detect a USB mass storage device, only a keyboard (or keyboard and virtual COM port).

When you remove the jumper across LOCK and restart the VTAP50, it will be detected as a USB mass storage device and you can make firmware or configuration changes again.

8 Find your hardware version

If you need to report a problem with your VTAP50 or find the right reference diagram you will need to know your hardware version.

If you can connect your VTAP50 to a PC, you can easily check the BOOT.TXT file.

If you navigate to the VTAP50 in the computer's file system. It will appear as an attached mass storage device and list the files contained, including the `BOOT.TXT` file.

Inspecting `BOOT.TXT` you will find a number next to the word `Hardware :` such as `v2`. This is the Hardware version in use.

Alternatively, over a serial connection to the VTAP50, sending the `?b` command will return the `BOOT.TXT` information.

If you cannot power the VTAP50

You will find the version number is printed on the PCB, such as "VTAP50-V2 Rev4 DOT ORIGIN ©2022" in the photo below, which is VTAP50 v2 hardware.

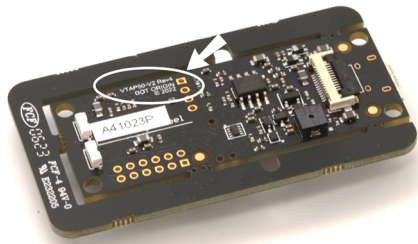

9 Disposal

For safety and sustainability, it is the responsibility of the integrator to ensure that when equipment containing a VTAP50 reaches the end of its life, it is recycled in accordance with WEEE Regulations within the EU.



VTAP50 (PCB and cables) should not be disposed of in general waste. If you wish to discard electrical and electronic equipment (EEE), please contact your supplier for further information.



A Tested external antennas

The antenna types listed below have all been tested by Dot Origin, in place of the VTAP50-OEM integrated loop antenna, and found to be compatible.

Table A-1 Tested external off-the-shelf antennas

Manufacturer	Antenna model	Antenna description	Dimensions	Certification status
Pulse Antennas	W7002	NFC wire loop antenna	94mm x 56mm	No certification
Pulse Antennas	W7013	Planar NFC antenna with ferrite	30mm x 25mm	No certification
Molex Antennas	146236-2131	NFC coil with AWG28 wire and connector	45mm x 55mm	No certification
Molex Antennas	146236-2122	NFC coil with AWG28 wire and connector	34mm x 46mm	No certification
Molex Antennas	146236-2102	NFC coil with AWG28 wire and connector	15mm x 25mm	No certification
Molex Antennas	146236-2151	NFC coil with AWG28 wire and connector	15mm x 15mm	No certification

Table A-2 Tested external custom antennas

Custom antenna reference	Dimensions	Certification status
ANT-1	40mm x 40mm	No certification
ANT-2	82mm x 22mm	FCC/ISED certified

Custom antennas are usually developed for third-parties and are not available for sale.

Note: When an external antenna is attached to the VTAP50, that new arrangement will require a corresponding tuning circuit and EMC approvals. Contact vtap-support@dotorigin.com for details about tuning circuits and EMC approvals for the tested external antennas.